



PRIMEDIC
Saves Life. Everywhere.



Automated External Defibrillator Instructions for use

HeartSave Y | YA

English

24335 EN
Revision: D1
Date of issue: 08/2024



Masthead

Publisher

Manufacturer: Jiangsu Yuyue Medical Equipment & Supply Co., Ltd
Address: No.1 Baisheng Road Development Zone, Danyang, Jiangsu
People's Republic of China

Tel.: 86-511-86900833

Fax: 86-511-86900851

Postal code: 212300

Web: www.yuwell.com/en



Metrax GmbH

Address: Rheinwaldstr. 22, D-78628 Rottweil, Germany



Proprietary note

The manufacturer reserves all rights to these operating instructions. Without approval from the manufacturer, these operating instructions may not be duplicated or made accessible to third parties. The same applies to individual parts or excerpts of these operating instructions.

Non-compliance may result in claims for damages and could have criminal law consequences (refer to DIN 34).

Revision: D1

Date of issue: 08/2024

These instructions for use may be changed by the manufacturer without further notice.

Contents

1	Glossary	5
2	Introduction	5
2.1	Foreword	5
2.2	Validity	5
2.3	Disclaimers	6
2.4	Symbols used in these instructions	6
2.5	Pictogrammes	7
2.6	Summarized operating instructions	9
3	Intended use	10
3.1	Medical indication	10
3.2	Medical contraindication	10
4	Safety information	10
4.1	General safety advice	10
4.2	Safety notes for the user	11
4.3	Safety notes to protect the patient	12
4.4	Safety notes for the protection of third parties	13
4.5	Safety notes for protection of the device	13
5	Description of device	13
5.1	General description	13
5.2	Device description	14
5.3	Accessory kit of the HeartSave Y YA	16
5.4	Status display	16
6	Preparatory measures before (initial) start-up	17
6.1	Unpacking	17
6.2	Inserting electrode	17
6.3	Install the battery	18
6.3.1	Battery safe information	18
6.3.2	Insert battery.	18
6.3.3	Battery removal	19
6.4	Self-test	19
6.4.1	Self-test when switch on the device	19
6.4.2	Periodic automatic self-tests	20
6.4.3	Automatic monitoring of the device	20
6.5	Language button	20
7	Using the HeartSave	21
7.1	Examining and preparing the patient	21
7.2	Switching on HeartSave Y YA	21
7.3	Check the patient category	22
7.4	Plug in electrode cable	22



7.5	Prepare the patient	22
7.5.1	Removing clothes from patient	23
7.5.2	Placing electrodes	23
7.6	Carrying out the ECG analysis	25
7.7	Defibrillation	25
7.8	Cardio-pulmonary resuscitation (CPR)	26
7.8.1	CPR for trained rescuers	27
7.8.2	CPR for lay rescuers	27
7.8.3	CPR configuration of the HeartSave Y YA	27
7.8.4	CPR metronome function	27
7.9	Keeping the defibrillator ready for use	28
8	Data management	28
8.1	Data storage	28
8.2	Data output	28
8.3	Configuration item	28
9	Accessories	29
9.1	Standard accessories	29
10	Troubleshooting	30
11	Cleaning, maintenance, despatch and disposal	30
11.1	Cleaning	30
11.2	Servicing	31
11.3	Sending the HeartSave Y YA	31
11.4	Disposal	31
Appendix A: Technical Data		33
Appendix B: Warranty		37
Appendix C: Rhythm detection system		38
Appendix D: EMC		39
Appendix E: Index Diagram		42

1 Glossary

Term / abbreviation	Description
AED	Automated external defibrillator
AHA	American Heart Association
Biphasic impulse	The current flow of the defibrillator changes direction during shock appliance
BLS	Basic resuscitation measures
CPR	Cardiopulmonary Resuscitation
ECG	Electrocardiogram
ERC Guidelines	European Resuscitation Council on Cardiopulmonary Resuscitation (CPR)
EU	European Union
MDD	Medical Device Directive
MIT	Massachusetts Institute of Technology
MPBetreibV	Medical Device Operator Ordinance
MPG	Medical Devices Act
Patient impedance	Patient resistance between the Electrode Pads

2 Introduction

2.1 Foreword

Dear User,

You may need to use the HeartSave Y|YA on individuals in a medical emergency.

So that you react quickly and properly in these special circumstances and make optimal use of the opportunity the device provides you with, we recommend that you take your time carefully to read through these instructions for use beforehand, thus familiarising yourself with the device, its functions and applications.

Keep these instructions for use near the device so that you consult them for any queries which might arise.

If you have any questions regarding the start-up, use or maintenance of the HeartSave Y|YA, please do not hesitate to contact us.

In case of unexpected device behaviour or events, please contact us.

Serious incidents related to the defibrillator must be reported. If the defibrillator has not performed as expected, contact the manufacturer and the appropriate local authority.

A "serious incident" means an event that has had, could have had, or may have had, directly or indirectly, any of the following consequences such as

- the death of a patient, user or other person
- the temporary or permanent serious deterioration of the health status of a patient, user or other person
- a serious risk to public health.

You will find our contact address on the masthead at the start of these instructions for use.

The instructions given on the device are no substitute for reading these operating instructions.

2.2 Validity

The descriptions in these operating instructions refer to the HeartSave Y | YA series automatic external defibrillator device made by Jiangsu Yuyue. The HeartSave Y | YA series automatic external defibrillator is referred to as HeartSave in the following operating instructions.

The content of this document can be changed from the manufacturer without prior notice.

2.3 Disclaimers

Liability claims in the event of damages to people or property are excluded if they are based on one or more of the following reasons:

Using the device in a manner for which it was not intended.

Improper use and maintenance of the device.

Operating the device with the protective covers removed or when there is obvious damage to cables and/or defibrillation electrode.

Non-compliance with operating instructions with regard to operation, maintenance and repair of the device.

Using accessories and spare parts made by other manufacturers.

Autonomous intervention, repairs or constructional changes to the device.

Lack of monitoring of parts or accessories that are subject to wear and tear.

2.4 Symbols used in these instructions



DANGER

Texts marked DANGER indicate an extraordinarily serious, current danger which will definitely lead to serious injury or even death if no preventative measures are adopted.

It is imperative that you follow these instructions!



WARNING

Texts marked WARNING indicate extraordinarily serious, possible dangers which, should no preventative measures be taken, may lead to serious injury or even death.

It is imperative that you follow these instructions!



CAUTION

Texts marked with CAUTION indicate a possible dangerous situation which could lead to minor injuries.

It is imperative that you follow these instructions!

ATTENTION

Texts marked with ATTENTION indicate possible property damage.

It is imperative that you follow these instructions!

NOTE This symbol indicates text which contains important advice / comments or tips.

The instructions are described in the following manner. Follow the instructions in the order in which they are described in the instructions.

▶ First instruction

▶ Second instruction

▶ etc.















• This line marks lists

(3) Numbers in brackets refer to items in diagrams.

< ... > Texts set in angle brackets denote acoustic information / instructions for the device

2.5 Pictogrammes

	The product bears CE mark indicating its conformity with the provisions of the Council Directive 93/42/EEC concerning medical devices and fulfil the essential requirements of Annex I of this directive.
	Dust-protected Protected against water jets.
	Refer to instruction manual/booklet.
	Environmentally friendly use
	Do not dispose of device in domestic refuse.
	Dangerous voltage.
	Defibrillation-proof type BF applied part.
	Manufacturer
	Authorised representative in the European community
	Use-by date
	Protect battery from fire.
	Do not charge battery
	Recyclable
	Do not re-use
	not sterile
	Can be used a maximum for 24 hours after opening
	Permissible temperature range in C

	Permissible air humidity range in %
	Permissible air pressure specification in hPa
	Keep away from sunlight
	Keep dry
 max.50 x	Maximum number of defibrillation shocks up to 50 times
	Latex free
	Do not bend or fold the electrodes
	Do no use if package is damaged
	Batch code
	Article number
	Caution
	Date of manufacture
	Serial number
	Non-ionizing electromagnetic radiation

2.6 Summarized operating instructions

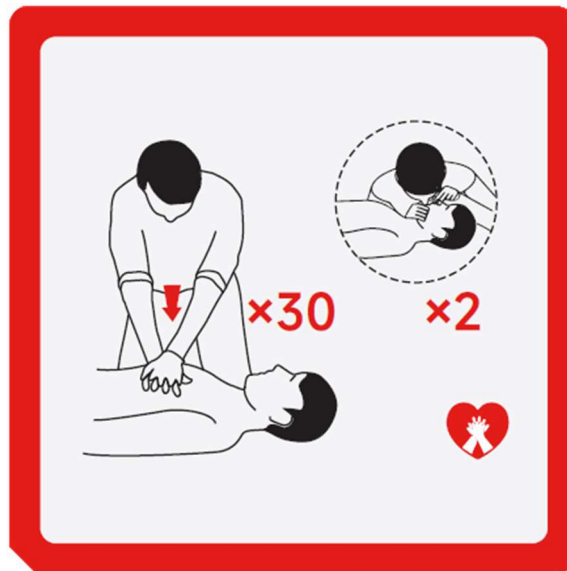
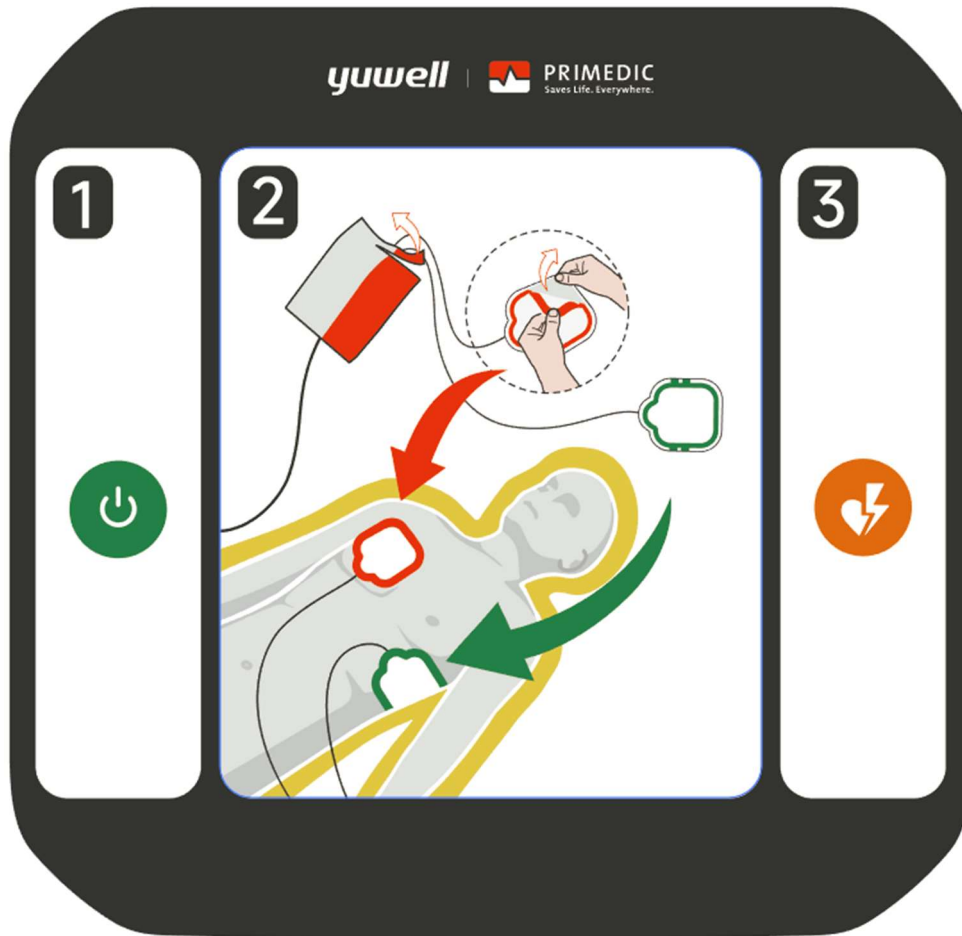

The brief instructions can be found on the device and helps you with the use of the HeartSave Y | YA series.

3 Intended use

The HeartSave Y | YA series automatic external defibrillator, is intended to be used on adults and children in a ventricular fibrillation.

HeartSave Y | YA series also guide operator throughout cardiopulmonary resuscitation (CPR) with voice guidance.

When a patient develops ventricular fibrillation or ventricular tachycardia, the device gives a shock to the heart to restore the disordered rhythm to normal.

The HeartSave Y | YA series is kept on the patient until professional assistance arrives even if the patient starts to breathe again.

The equipment is designed for treating adult patients and children patients in combination with the Electrode Pads OBS-DE/P. Patients aged 8 years and above and / or with a weight over 25 kg are treated as adults. Patients aged 1-8 weighing less than 25 kg are treated as children.

NOTE HeartSave Y | YA series defibrillators may only be used as described and under the conditions detailed in these operating instructions!



DANGER

Warning: physical harm

Risk of heart arrhythmia which may lead to death

- Only use HeartSave Y | YA series as intended
- Don't use the HeartSave on children aged under 1 year



CAUTION

In an emergency case the HeartSave Y | YA series can operate for at least 20 minutes from temperature to -20 °C.

3.1 Medical indication

HeartSave Y | YA should be used when the patient has all of the following symptoms:

- Unconsciousness
- Absence of normal breathing
- Absence of signs of circulation

3.2 Medical contraindication

HeartSave Y | YA should not be used if the patient shows one of the following symptoms:

- Consciousness
- Breathing
- Signs of circulation

4 Safety information

4.1 General safety advice

The HeartSave Y | YA series fulfills the currently applicable safety standards and complies with the provisions of medical product regulations. The power supply of HeartSave Y|YA series comes from a non-rechargeable lithium battery.

HeartSave Y | YA and its accessories are safe when used as intended and when following the descriptions and information detailed in these operating instructions.

Despite this, if used incorrectly, HeartSave Y | YA series and its accessories can be dangerous to the user, the patient or third parties.

NOTE	Take care of the ambient conditions in the technical specifications when storing and operating the device. Always follow the commands issued by HeartSave Y YA series. Do not use the HeartSave Y YA series in the presence of flammable materials. Keep the device away from children.
-------------	--



DANGER

The device should not be used in the vicinity of flammable materials (e.g. cleaning solvents or similar) or in an atmosphere enriched with oxygen or flammable gases/vapours. Always check the environment condition during usage of the device.

Do not use the device in locations where there is a risk of explosion.

4.2 Safety notes for the user



WARNING

Only use the device on a patient if:

- You have ensured its operational safety before using it and that it is in good condition.
- the state of the patient requires or allows an application of defibrillator.

Before using the device, ensure the environment temperature is in the range of operating temperature specification.

Do not apply the device if it is defect or visible damaged (e.g. damage of cables or housing of the device HeartSave Y|YA)



4.3 Safety notes to protect the patient



DANGER

To use HeartSave Y|YA series on a patient, you must:

- Do not use the device on a patient unless you ensure the operational safety.
- Check the device before use to guarantee it is in good condition.
- If the device is defective (e.g. damage of defibrillation electrode cable), do not use the device.
- Use new, undamaged, and unexpired defibrillation electrodes for every patient to avoid any possible burns to the skin.
- Only connect PRIMEDIC electrodes to the HeartSave Y|YA defibrillators.
- Do not use the device close or near to other sensitive equipment (e.g. some measuring equipment are always sensitive to magnetic fields) or strong sources of interference. Keep a sufficient distance away from other energy sources (e.g. microwave oven, induction stove, etc.).

These devices may cause HeartSave Y|YA devices not working properly or doesn't work. Please make sure to disconnect all other devices from the patient before defibrillation.

- Prior to defibrillation, disconnect all other electrically operated medical devices that are not defibrillation-proof and are used on the patient.
- Keep the defibrillation electrodes away from other electrodes, metal objects and earthed objects.
- Do not use the device on infants under 12-month old.
- Place the defibrillation electrode precisely according to the image guidance.
- Dry the chest and if there is a large amount of hair on the chest, carefully remove it before applying the defibrillation electrode.
- Do not place the defibrillation electrodes over any implanted pacemaker to avoid a possible damage to the pacemaker from the defibrillation energy.
- Do not touch the patient during ECG analysis.
- Stop CPR while HeartSave Y|YA defibrillator is under ECG analysing.
- No touch of other medical devices which may present a danger to the patient as a result of the cumulation of currents.



WARNING

Be aware of the defibrillation electrode cable:

Strangulation may occur by defibrillation electrode cables to the patient.

Be aware of shock energy:

AED defibrillation works by depolarizing the cardiac muscle with electric current. To achieve the intended purpose, AEDs need to release a large amount of electrical energy (less than 360J). This electrical energy can potentially lead to myocardial damage.

4.4 Safety notes for the protection of third parties



DANGER

Warning surrounding people loudly and clearly before defibrillation to make sure they have no contact with the patient.

4.5 Safety notes for protection of the device



WARNING

Repair and installation of HeartSave Y|YA devices should be carried out by professional authorized persons only.

Use original accessories from the manufacturer only.

Clean the device as guided in this instruction of use.



WARNING

If any serious incident occurred in relation to the device, please report to us and the competent authority of the Member State in which you are established.

5 Description of device

5.1 General description

The HeartSave Y | YA series is an automatic external defibrillator (AED) with an integrated Single Channel ECG.

The ECG is recorded using the Electrode Pads. When a rhythm requiring defibrillation is detected, the HeartSave Y | YA provides a shock to restore the heart rhythm.

There are two type of product models provided: semi-automatic and fully automatic.

Characteristics of models are detailed in the following table.

Defibrillation mode	Model	Shock button
Semi-automatic external defibrillator	HeartSave Y	YES
Fully-automatic external defibrillator	HeartSave YA	NO

HeartSave Y | YA series is equipped with device, defibrillation electrode and battery. You could also check chapter 5.2 for detailed information.

HeartSave Y | YA series is designed to be safe and quick to use for emergency. The power supply of The HeartSave Y | YA series is powered by a non-rechargeable lithium battery.

5.2 Device description

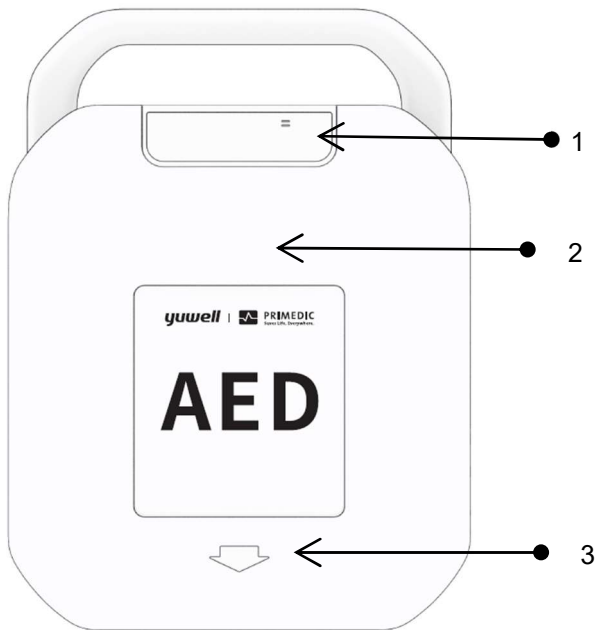

Fig. 1 Front view with lid

- (1) Status display
- (2) Device lid
- (3) Open the lid as directed by the arrow

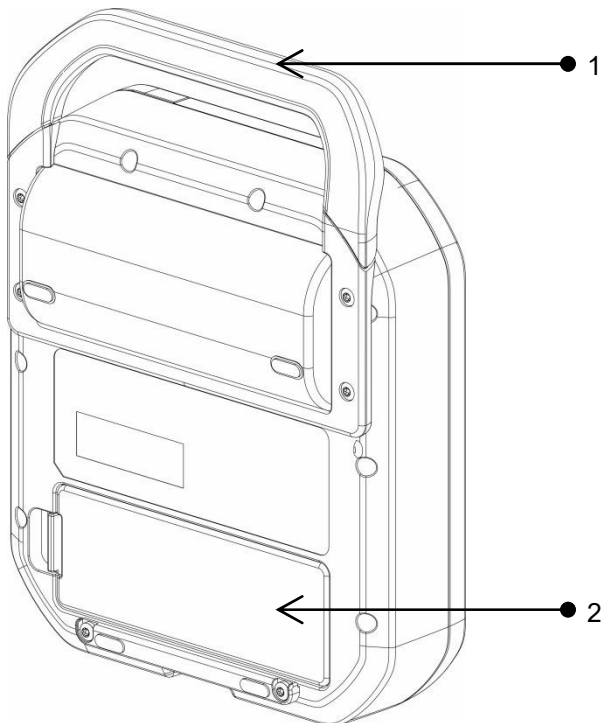

Fig. 2 Back View

- (1) Carrying handle
- (2) Battery



Fig. 3 Bottom View

(1) Device lid latch

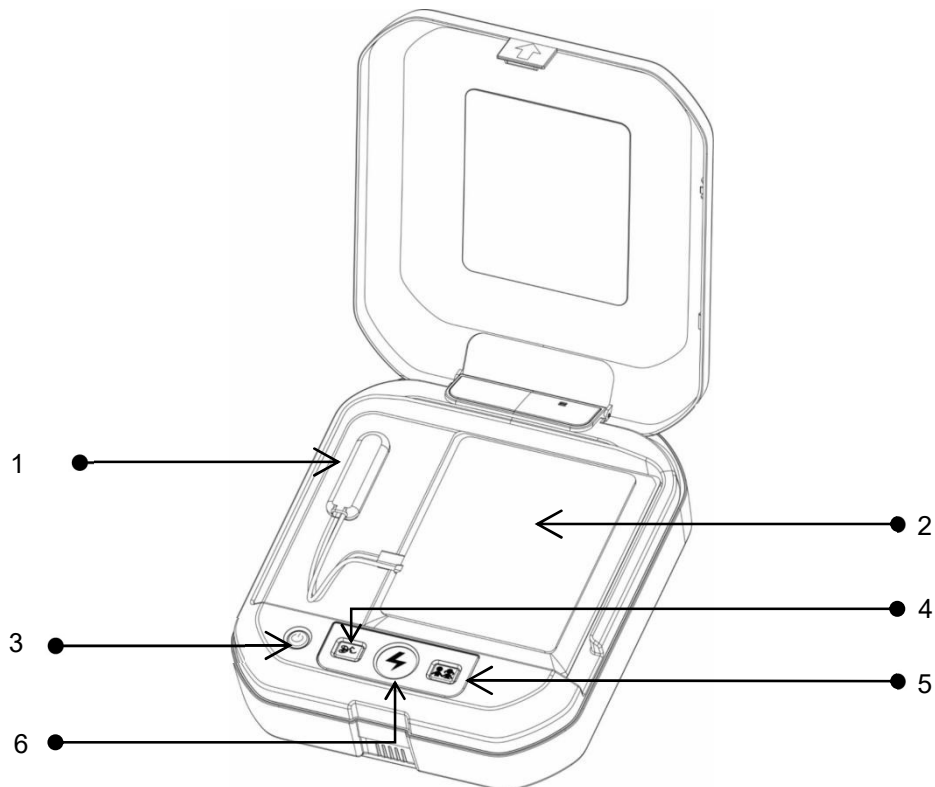

Fig. 4 HeartSave Y | YA series front view

- (1) Socket for defibrillation electrode and USB
- (2) Defibrillation electrode
- (3) On/Off switch with green back-light
When back-light is green: device switched on as ready for operation
- (4) Language button
- (5) Child button with back-light
When back-light is green: child mode activated
When back-light not illuminated: adult mode
- (6) Shock button with red back-light (only for HeartSave Y series), flashing when ready to shock
Red back-light (only for HeartSave YA series)

5.3 Accessory kit of the HeartSave Y | YA

The emergency kit is attached to the back of the HeartSave Y | YA and contains the following accessories:





- 1x Scissor
- 1x Disposable razor
- 1x Pair of disposable gloves
- 1x Resuscitation mask

Fig. 5 Accessory kit of the HeartSave Y | YA

5.4 Status display

In the table below is a list of the possible things displayed in the status display and their meanings.

Display.	Meaning	Action to be taken
	Normal status	Device ready to use.
	Indication of a possible error or during self-test	<ul style="list-style-type: none"> - Device may be ready for use in an emergency. - Nearly time to replace battery. - Insert the battery. - Plugin defibrillation electrode. - Renew defibrillation electrode. - In case of an internal error, contact the service department.

The following indications of a possible error may be responsible for the "X" in the status display.

Reason	Possible to use?	Procedure
Defibrillation electrode not connected	Yes, device is ready for use.	Connect the defibrillation electrode for use of the device.
Battery almost empty	Yes, device possible to release at least 6 shocks of 360J.	Indication of battery low by voice prompt. The device could be used until battery empty.
Battery empty	No, device is not ready for use.	Indication of the empty battery by voice prompt. The device will automatically shut down.
Internal error	No, device is not ready for use.	Indication of an internal error by voice prompt. The device will automatically shut down.

NOTE If the battery is empty and the display shows



a warning tone sounds when the device is switched on and the following voice command is issued:

< **Low Battery! Please replace battery as soon as possible. Continue to use the device if no replacement available** > or < **Battery error** >

6 Preparatory measures before (initial) start-up

6.1 Unpacking



DANGER

Danger caused by damaged device

- Do not use damaged devices

Upon receiving the delivery, check for transport damage to the packaging and the device. Check whether the delivered package is complete as listed according to enclosed delivery note.

If you notice any damage, immediately contact your logistic supplier, dealer or directly contact authorized service. Provide them serial number and describe the damage of the device.

6.2 Inserting electrode

The defibrillation electrode on the HeartSave Y|YA are pre-connected at the factory and do not need to be additionally plugged in before first use. However, if defibrillation electrode were replaced or unplugged, they must be reconnected to the device with the following steps.



Fig. 6 Inserting defibrillation electrode

Installation procedure:

- ▶ Pull the latch to open the lid.
- ▶ Insert the defibrillation electrode plug into the socket.
- ▶ Place the defibrillation electrode into the device.

ATTENTION

Status display may show “X” after replacing defibrillation electrode

- In this case, please open the lid or press the on/off button to switch on the device. Wait until self-test finish and device status display will show “OK”.



WARNING

- Keep the defibrillation electrode always plugged in.
- Do not open the defibrillation electrode pouch except immediately prior to use.
- Do not bend the defibrillation electrode with extra force.
- Check the seals of defibrillation electrode pouch/cable and expiry date before use.

6.3 Install the battery

The power supply of the HeartSave Y|YA series comes from a non-rechargeable lithium battery. Before first use of HeartSave Y|YA, the battery transport seal must be removed and insert the battery into the device.

6.3.1 Battery safe information



WARNING

- **DO NOT CHARGE THE BATTERY! RISK OF EXPLOSION!**
- Do not disassemble, puncture or incinerate batteries. Do not short the battery terminals. They may ignite, explode, or leak, causing personal injury.
- Do not place the battery close to fire or heat.
- Please avoid storage under direct sunlight.
- Do not use other batteries on HeartSave Y|YA to prevent unsafe device operation.

ATTENTION

- Always take care of the battery expiry date.
- Replace the battery if it is expired.

Keep the documents which enclosed with the battery and follow the operating instruction for safety and further potential checks.

NOTE If the device must be sent to customer services, remove the battery, and use tape to cover the battery contacts.
Check if any battery special shipping regulations in case of battery shipment or send the battery to customer service.

6.3.2 Insert battery.

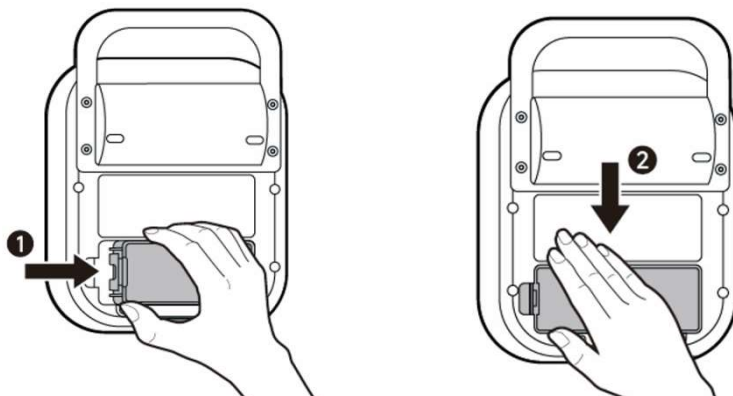

Fig. 7 Insert the battery

Procedure:

- ▶ Put the device top down on a flat surface.
- ▶ Push the (new) battery (1) in the direction of the arrow into the device until it reaches its end position as shown in the diagram.
- ▶ Then press the battery in the direction of the arrow (2) into the battery slot until the battery flap securely in the slot.
- ▶ Press the battery completely into the device until you hear a 'click' as it slides into the slot.
- ▶ When battery inserted, the device will carry out a self-test. Follow the voice messages.
- ▶ After self-test has been done successfully, the device is ready for use.

ATTENTION

Status display may show “X” after battery insertion

- If status display does not show 'OK', follow the steps below:
Switch on the device again and wait for a complete self-test finish.

6.3.3 Battery removal

NOTE Only remove battery when the device is switched off.

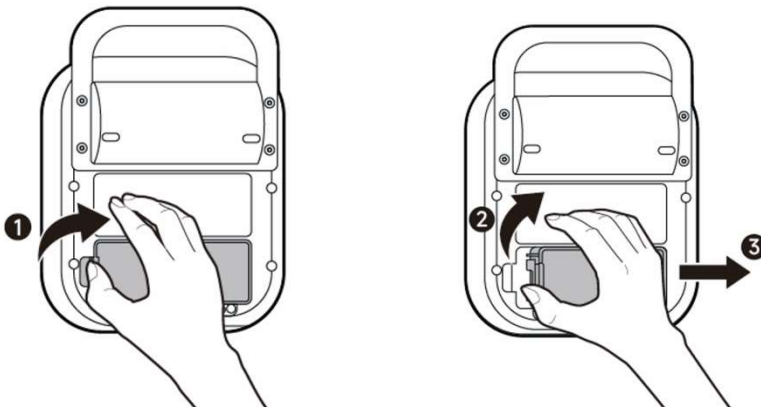

Fig. 8 Removing the battery

Procedure:

- ▶ Put the device top down on a flat surface.
- ▶ Press the unlocking flap (1) to the right until the flap on the battery is released and the battery is out of the slot slightly.
- ▶ Push the battery slightly in the direction of the arrow (2) and then pull it in the direction of the arrow (3) out of the device.

6.4 Self-test

6.4.1 Self-test when switch on the device

When HeartSave Y|YA is switched on by opening the lid or pressing on/off button, the device performs a quick self-test to check all key functions and signal mechanisms.

When the battery is inserted into the HeartSave Y|YA, the device will perform a manual self-test.

Manual self-test

Please follow the instructions of the device after inserting the battery:

With a ticking metronome sound, the devices signals that the self-test is in process.



1. The lid must be closed for the manual self-test.
If the lid is open after inserting the battery, the device will give the voice prompt < **Close the lid** >. After three repetitions without closing the lid the test will be continued.
2. The device will give the voice prompt < **Device testing, if defibrillation is needed, please open the lid and press the power button to interrupt the test** >.
3. The device will make a short audio test.
4. < **Self testing please wait** >
5. The device will give the voice prompt < **Manual self-check, please open the lid and follow the instructions** >
Open the lid of the device.
6. The device will give the voice prompt < **Unplug electrodes** >
Unplug defibrillation electrode.
7. The device will give the voice prompt < **Plug in electrodes** >
Plug in defibrillation electrode.
8. The device will give the voice prompt < **Please press the blinking buttons** >
Press language button
Press Shock button
Press child button
9. The device will give the voice prompt < **Test completed** >
Voice prompt < **Device okay** > if the devices functionality is guaranteed.
Voice prompt < **Device not ready for use** > – Please execute the test again. If it is not successful, please contact our service team.

6.4.2 Periodic automatic self-tests

The HeartSave Y|YA carries automatic self-tests to ensure that it is always ready for operation.

Type of test	Test coverage
Daily*	Check main control module, battery, speaker, internal power module, defibrillation electrode, treatment module.
Monthly (First day of each month)	Check main control module, battery, speaker, internal power module, defibrillation electrode, treatment module, 1J charge and discharge and 200J charge and discharge, speaker.
Half-year (01.01 and 01.07 of every year)	Check main control module, battery, speaker, internal power module, defibrillation electrode, treatment module, 1J charge and discharge and 360J charge and discharge, speaker.

* The daily self-test is set to “05:00 a.m.” of the time zone. The self-test time depends on time zone setting.

NOTE The device is not able to perform automatic time zone update.
Time zone setting should be done by HeartSave Y|YA configuration tool.

6.4.3 Automatic monitoring of the device

The HeartSave Y|YA device continuously perform internal monitoring of functions and safety. In case of any fatal error or malfunction of the device, the status display will show "X" and prompts a signal tone regularly. Please check the device status display from time to time.

NOTE Under some circumstances this “X” might present temporarily or could be reversible. In these cases, you could use battery insertion to perform self-test to fix. If it is helpful, you can continue to use the devices. If it is not helpful, please contact our customer service department for help.

6.5 Language button

You can press the language selection button during operation until the desired language is selected. The HeartSave Y|YA optionally supports up to 4 languages. With pressing the language button, the selected language is briefly announced.

7 Using the HeartSave

NOTE The sequence of the reanimation is realized in the device according to the recommended guidelines of the European Resuscitation Council or American Heart Association.



DANGER

Warning of explosion

Risk of burns

- Do not use the device in potentially explosive areas.
- Do not use the device in oxygen-enriched atmospheres.
- Do not use the device close to flammable materials.



WARNING

Warning: physical harm

Risk of skin burns

- Remove hair at the defibrillation electrode placing area.
- Where necessary, dry the skin before attaching the defibrillation electrode.

ATTENTION

Material damage to other devices

- Remove all devices which are at risk from the defibrillation from patients before defibrillation.

7.1 Examining and preparing the patient

Check to see whether the patient is unconscious and is not breathing as usual. Do following steps:

- ▶ Approach the patient, call out to them, and tap their body to check for consciousness.
- ▶ If the patient does not respond, place your ear near the patient's neck and check for any signs of breathing.
- ▶ If the patient is not breathing as usual, expose the chest area and attach defibrillation electrodes. If the defibrillator is not yet available, ask others to retrieve it immediately.
- ▶ Using the supplied razor, remove chest hair from the area where the defibrillation electrodes will be attached.
- ▶ If the skin is wet, dry the skin at the position where the defibrillation electrodes will be attached to ensure adhesion.
- ▶ If the skin has any lint, dust or dirt on, please clean before attach defibrillation electrodes.
- ▶ Make sure to call emergency services.

7.2 Switching on HeartSave Y|YA

The HeartSave Y|YA automatically activates when the lid is opened. If the device is not switched on automatically, switch it on by pressing the on/off switch button. When device is switched on, all option buttons are selectable, except shock button (HeartSave Y only) because defibrillation function is not possible to be triggered unless the device has detected a defibrillation required rhythm.

Immediately after the device is switched on, a quick self-test is carried out to check key functions of the device.

When device is switched on, the following prompts are issued:

< Power on >

< Call emergency services >

< Analysing rhythm, don't touch the patient >

If the defibrillation electrode are plugged into the socket and not connected to the patient, following prompts are issued:

< Power on >

< Call emergency services >

< Plug in electrodes>

7.3 Check the patient category

The HeartSave Y|YA defibrillator can be used for adults or children. The child mode is only used for patients who are younger than 8 years or weigh less than 25 kg. Otherwise use the adult mode for patients.

You can press child button to switch to child mode. If HeartSave Y|YA is in child mode, the indicator LED of the child button will illuminate (green).

Child mode is specifically developed for the defibrillation of children. The child mode of HeartSave Y | YA supplies less energy than the adult mode.

NOTE The therapy should not be delayed in order to determine the precise age or weight of the patient.

7.4 Plug in electrode cable

NOTE If the defibrillation electrode plug is already inserted, then skip this step.

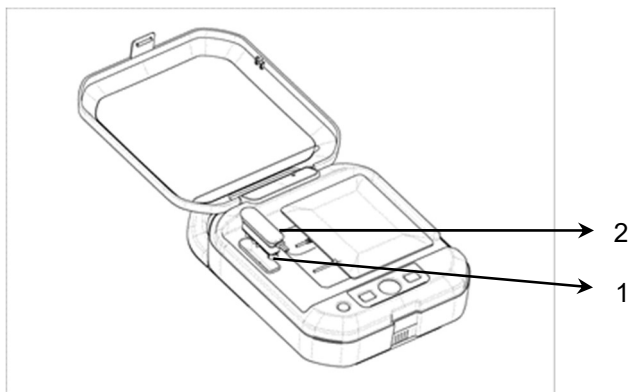

Fig. 9 Plug in defibrillation electrode cable

(1) Socket

(2) Defibrillation electrode plug

Steps:

- ▶ When hearing the voice prompt < **Plug in electrodes** > ,
- ▶ Insert the plug (2) of defibrillation electrode into the socket (1) on HeartSave Y|YA as shown above.

NOTE If defibrillation electrodes are not plugged in after several voice prompts, the device will switch to cardiopulmonary resuscitation automatically.
When defibrillation electrodes are plugged in, CPR instructions will be interrupted immediately.

7.5 Prepare the patient

NOTE Please wear the disposable gloves from accessory kit.

7.5.1 Removing clothes from patient

Use the supplied razor to remove chest hair from the area where the defibrillation electrode will be attached.

7.5.2 Placing electrodes

WARNING

Avoid damage to gel layer of defibrillation electrodes

Skin burning risk

- Be careful not to touch gel layer before attaching electrodes to patient
- Be careful, gel layer damage may cause skin burning.

CAUTION

- Do not use expired defibrillation electrode, damaged defibrillation electrode. Also do not use defibrillation electrode from damaged pouch.
- Check defibrillation electrode pouch to ensure integrity of seals and validity from expiry date.

If such defibrillation electrode are used for defibrillation, worse patient therapy or skin burning may occur.

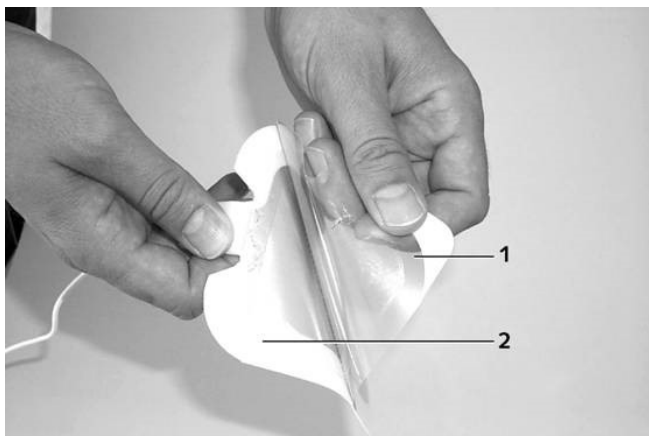

Fig. 10 Removing the foil from defibrillation electrode

- (1) Protection foil of defibrillation electrode
- (2) Defibrillation electrode

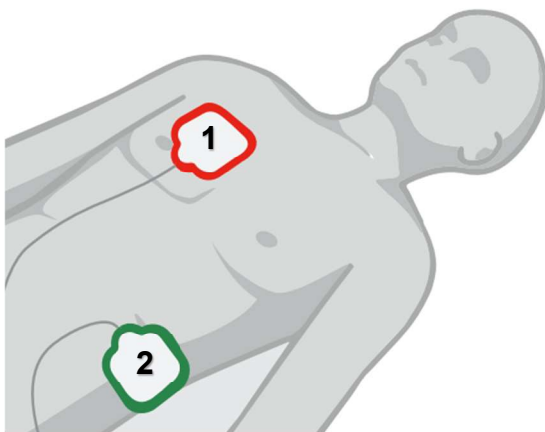

Fig. 11 Position of defibrillation electrode on adults

The positions of the defibrillation electrode are:

Red **1**: On the right chest area, below the collarbone and

Green **2**: On the left side of the chest, above the apex of the heart on the axillary line.

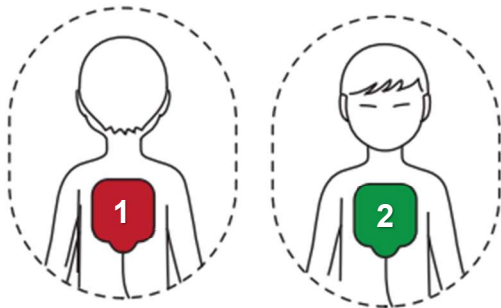

Fig. 12 Position of defibrillation electrode on children

The positions of the defibrillation electrode are:

Red **1**: on the back at the same height as the heart

Green **2**: in the middle of the chest

HeartSave Y|YA will give a voice prompt to guide you applying defibrillation electrode to the patient.

< Apply electrodes as shown >

< Remove all clothing from patient's chest, unpack defibrillation electrode and apply them to patient's bare chest as shown >

Steps:

- ▶ Open the defibrillation electrodes pouch.
- ▶ Remove the protection foil from one of the defibrillation electrode and then immediately place the defibrillation electrode onto specified position. (Refer to Fig. 11 for adults and Fig. 12 for children)
- ▶ Then remove the protection foil from the second defibrillation electrode and place onto specified position.
- ▶ Press defibrillation electrode carefully to ensure good contact and no air bubbles under defibrillation electrode!

NOTE If defibrillation electrode are not attached to the patient after several voice prompts, the device will switch to cardiopulmonary resuscitation automatically.

When defibrillation electrode are well applied to patient, CPR instructions will be interrupted immediately.

It is recommended to use following models of defibrillation electrodes, which with CE marking for defibrillation.

Manufacture	Model	Remark
Baisheng Medical Co., Ltd.	OBS-DE/P	See Appendix A for details



WARNING

If electrodes are not well applied, ECG signal may not possible to be analysed

In this case, device will provide voice prompt:

< Apply electrodes as shown >

7.6 Carrying out the ECG analysis

If defibrillation electrodes applied, the device will start rhythm analysis automatically.

The patient should be placed in a stable position and not be touched. The device will provide voice prompts:

< Analysing rhythm, don't touch the patient >

The device algorithm will evaluate ECG signal of patient whether defibrillation is required.

7.7 Defibrillation



DANGER

Danger of damage to health of user, patient or a third party

Triggering heart arrhythmia

- Do not touch the patient during defibrillation
- Warn third parties about the dangers of defibrillation
- If the patient wakes up during reanimation, stop the resuscitation

NOTE Pressing the shock key during capacitor charging (before it turns red) will not result in release of shock.

NOTE Defibrillation may cause muscle contractions of the patient.

NOTE When device is charging or ready for shock:

- if device still detects a shockable rhythm, the device won't abort defibrillation process unless manual abortion.
- if device detects a non-shockable rhythm, the device will abort defibrillation process automatically.

If the device clearly identifies ventricular fibrillation (VF), it will recommend defibrillation. The device issues voice prompts:

HeartSave Y series semi-automatic external defibrillator	HeartSave YA series fully-automatic external defibrillator
 < Don't touch the patient, press flashing shock button, deliver shock now >	< Don't touch the patient, shock will be delivered in: "Three", "Two", "One" >
A continuous tone and the shock button flashes " orange " Press the shock button in time according to the voice instruction	Automatically administer a shock without requiring further action

After shock delivered, no ECG analysis again, the device will proceed with cardio-pulmonary resuscitation (CPR).

Defibrillation and CPR are repeated according to the directives of the ERC-Guidelines.

If the device cannot find a shockable rhythm, you will hear:



< No shock advised >

< Safe touching patient >

< Begin CPR >

7.8 Cardio-pulmonary resuscitation (CPR)

As a configuration of the HeartSave Y | YA for CPR we follow the recommendations of the 2021 ERC guidelines. The 2021 ERC guidelines differentiate the approach to resuscitation for trained and lay rescuers.

7.8.1 CPR for trained rescuers

The 2021 ERC guidelines recommend that trained first responders perform 2 ventilations after chest compressions. For trained first responders, different procedures are recommended for adults and children. For adults, ERC2021 recommends 30 chest compressions alternating with 2 ventilations. For children, ERC2021 recommends 15 chest compressions alternating with 2 ventilations.

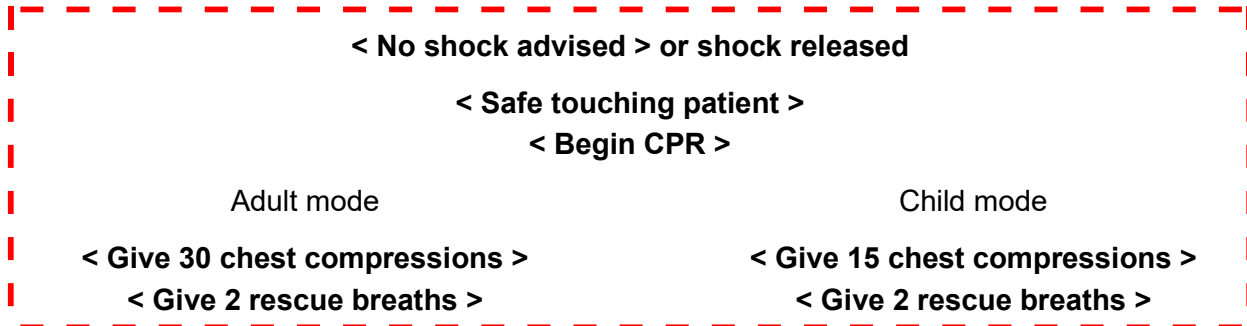

7.8.2 CPR for lay rescuers

The 2021 ERC guidelines recommend that untrained adult first responders perform only continuous chest compressions during resuscitation, without ventilations. If the first responder has not completed separate training in pediatric basic resuscitation, ERC-2021 recommends 30 chest compressions with 2 ventilations or continuous chest compressions in children during CPR.

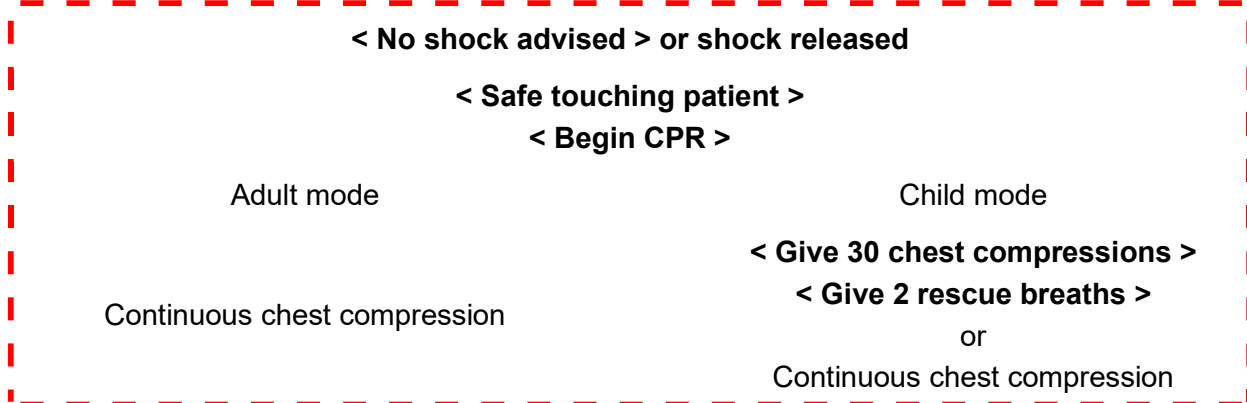

7.8.3 CPR configuration of the HeartSave Y | YA

The HeartSave offers the possibility to configure cardiopulmonary resuscitation measures as customer requirement. For instance, it is possible to dispense with ventilation in adult mode and only perform chest compressions.

In child mode, we offer to increase configuration from 15 to 30 chest compressions + 2 ventilations. Continuous chest compressions is also valid for child mode.

The default CPR configuration is defined for CPR for trained rescuer. To change the configuration, please contact your dealer or customer service.

7.8.4 CPR metronome function

During chest compressions, HeartSave Y|YA also equipped with metronome function which guide you with correct frequency for chest compression. Please follow the rhythm. The last five CPR metronome tones sound slightly different to indicate a break after the compression cycle. The artificial respiration is also guided by two acoustic outputs. From the second to fifth CPR cycle, only these acoustic signals are provided by device.

NOTE When CPR period finishes (2 min.), device returns to ECG analysis.

Cardiopulmonary resuscitation (CPR) should be always performed until emergency service arrive.

7.9 Keeping the defibrillator ready for use

- ▶ Check if HeartSave Y|YA is damaged after each use.
- ▶ Clean HeartSave Y|YA and accessories after each use. Disinfect HeartSave Y|YA and accessories in case of infection risk, see section 11.1.
- ▶ Replace defibrillation electrode, check and replace battery if necessary.
- ▶ If any malfunctions or noticeable issues happened, please contact customer service.

HeartSave Y|YA has 3 options to switch off:

- Pressing on/off button for approx. 3 seconds. You will hear a beep accordingly
- Closing device lid.
- If the device does not recognize an operation for 30 minutes, it will switch off automatically.
- Wait at least 30 seconds after switching off before removing battery.

8 Data management

8.1 Data storage

The device supports the storage of the following data:

Data type	Data description
System log	Serial number, software release version, total time of operation, battery information, defibrillation electrode information
Therapy log	Record ECG Recorded impedance Delivered shock data
Event log	Error event, warning event, configuration event, information event
Audio log	Voice messages of the device

NOTE Once the storage capacity of the device is exhausted or the maximum number of files is reached there will be cyclic storage.

8.2 Data output

The HeartSave Y|YA support to export data from device to a storage device. This data may not be used for diagnostic purposes or therapy for the patient.

Follow these steps to export data from device:

- ▶ Plug in USB stick which includes M600-license file
- ▶ Switch on device
- ▶ When child button backlight continuously illuminated, data successfully exported.

For more details please contact your local distributor or manufacturer.

NOTE The USB storage for data export must be FAT32 formatted. The HeartSave Y|YA supports no other format or protocol.

8.3 Configuration item

The device is configured at factory.

NOTE To change the configurations, please contact your local distributor or the manufacturer. If the configuration is changed independently, the device is no longer ready for operation and reports "Internal Error".

9 Accessories

The accessory material that contacts the patients has undertaken the bio-compatibility test and is verified to be in compliance with ISO 10993-1.



WARNING

Use accessories specified in this chapter. The use of other accessories may cause damage to the equipment or not meet the claimed specifications.

Single-use accessories are not designed to be reused. Reuse may cause a complication and affect the measurement accuracy.



CAUTION

The accessories may not meet the performance specifications if stored or used outside the specified temperature and humidity ranges. If accessory performance is degraded due to aging or environmental conditions, contact authorized service personnel only.

9.1 Standard accessories

Name	Module	Remarks
Electrode	OBS-DE/P(303A1204)	Disposable defibrillation electrodes for adult and child
Battery	NRL01C	12V, 4.2Ah, not rechargeable

10 Troubleshooting

This section explains problems you may encounter while using the HeartSave Y|YA and provides information about keeping your defibrillator in a state of readiness.

Troubleshooting During Use:

Problem	Possible cause	What to do
Unable to power on	The battery may not be inserted in the device.	Insert battery.
	The battery may be depleted	According to the 6.3 to replace a new battery
State displays 	Internal error	Reboot device and execute self-test.
	The electrodes are not plugged in the AED	According to 6.2 insert the Electrode Pads
	The electrodes are expired	Changing the Electrode Pads
	The battery is low!	According to the 6.3 to replace a new battery
Voice instructions < Low Battery! Please replace battery as soon as possible >	Low Battery	According to the 6.3 to replace a new battery
Voice instructions < Battery depleted, device will automatically shut down >	Battery Depleted	According to the 6.3 to replace a new battery

If you encounter problems and faults that are difficult to solve or cannot be solved by yourself, please contact authorized service personnel.

11 Cleaning, maintenance, despatch and disposal

11.1 Cleaning

	WARNING
Warning: physical harm to user	
Risk of electrocution	
<ul style="list-style-type: none"> ➤ Clean the device only when it is switched off ➤ Do not immerse the device in liquids 	

Recommended cleaning agents are:

- Water
- Ethanol (75%)
- Isopropyl alcohol (70%)

To clean your equipment, follow these rules:

1. Shut down the equipment, disconnect cables, and remove the battery.
2. Clean the Status-Display using a soft, clean cloth dampened with a glass cleaner.
3. Clean the exterior surface of the equipment using a soft, clean cloth dampened with the recommended cleaning agents.
4. Wipe off all the cleaning solution with a dry cloth after cleaning if necessary.
5. Dry your equipment in a ventilated, cool place.

11.2 Servicing

ATTENTION

Warning: property damage

- Do not carry out any repairs to the device.
- Do not carry out any modifications to the device.
- Do not dismantle HeartSave Y|YA.
- Only use genuine accessories!
- Maintenance and service are not allowed during the use of the device.

We recommend performing a regular visual inspection of the device.

Ensure that the electrode pads, battery, and all other accessories are undamaged.

Check the device and accessories regularly. Select the intervals so that the operational readiness and operational safety of the device are permanently guaranteed.

For service questions please contact us directly under:

service@primedic.com

+49 741 257 275

11.3 Sending the HeartSave Y|YA



DANGER

Risk of fire due to short circuit

- Before sending, protect the contacts of the battery with insulating adhesive tape.

Where possible, use the original box. If the original box is no longer available, use suitable packaging materials make the device fixed and well wrapped to protect the HeartSave Y|YA from impact and damage.

Please hold carrying handles when transport device to an emergency place.

Pay attention to the national and international shipping regulations concerning the transport of Lithium batteries. Contact your dealer or the manufacturer for more info.

11.4 Disposal



CAUTION

Warning: physical harm

Risk of acid burns

- Dispose the device, battery and single parts according to local regulations



Fig. 13 Disposal

In accordance with the founding principles of the manufacturer, your product has been developed and made using high quality materials and components which are recyclable.

At the end of its service life, recycle the device through disposal companies registered under public law (council recycling facilities). Proper disposal of this product helps with environmental protection.



Through registration of Metrax GmbH with the responsible authorities, we ensure that the disposal and utilisation of electronics devices introduced onto the market by us is secure in accordance with the EU directive on the disposal of electronic and electrical equipment (WEEE-directive).

For business customers in the European Union

Please contact your dealer or supplier if you want to dispose of electrical and electronic equipment.

Appendix A: Technical Data

Defibrillation

Operating modes: HeartSave Y series: semi-automatic external defibrillator
HeartSave YA series: fully-automatic external defibrillator

Impulse shape: Biphasic truncated exponential, auto-compensation according to patient impedance.

Optional output energy For adults: 100 J, 150 J, 170 J, 200 J, 300 J, 360 J
For children: 10 J, 15 J, 20 J, 30 J, 50 J, 70 J, 100 J
Refer to Chapter 8.3 for the configuration methods

Default Shock series Default adult energy sequence:
Level 1: 200 J
Level 2: 300 J
Level 3: 360 J
Default children energy sequence:
Level 1: 50 J
Level 2: 70 J
Level 3: 100 J
Shocks: Level 1, level 2, and level 3 can be configured,
The energy configuration of the latter level must be greater than or equal to the energy of the previous level.
Meeting ERC guidelines 2021 and AHA guidelines 2020 by default

360J defibrillation waveform into impedance into of 25Ω, 50Ω, 75Ω, 100Ω, 125Ω, 150Ω, 175Ω

R (Ω)	25	50	75	100	125	150	175
10	9.7	10	9.7	9.3	8.9	8.5	8.1
15	15	15	15	14	13	13	12
20	20	20	20	19	18	17	16
30	29	30	29	28	27	25	24
50	49	50	49	47	45	43	41
70	68	70	68	65	62	60	57
100	97	100	97	93	89	85	81
150	146	150	146	140	134	128	122
170	166	170	166	159	151	145	138
200	195	200	195	187	178	170	163
300	292	300	292	280	267	255	244
360	351	360	350	336	321	306	293

Data in J ±10%

Waveform parameters

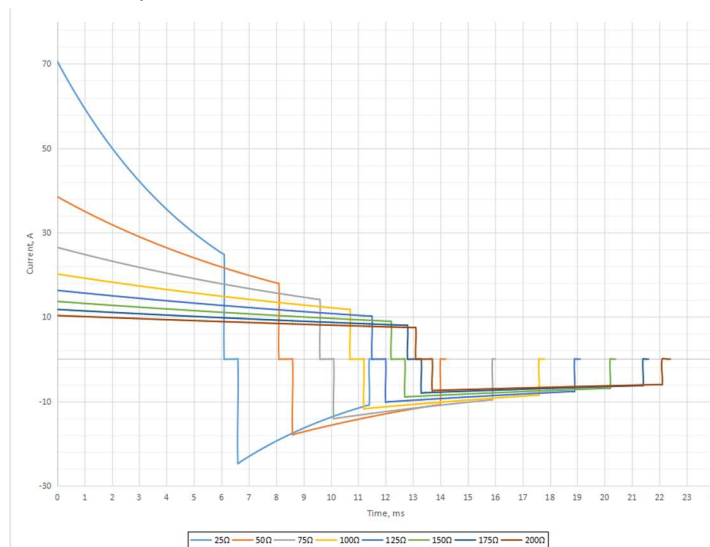

Charge time:

Parameter for the HeartSave Y | YA for charging the first shock:

1) new battery

From open device cover to charge 200 J done: no more than 7 s

From open device cover to charge 360 J done: no more than 14 s

From AED analysis to charge 200 J done: no more than 5 s

From AED analysis to charge 360 J done: no more than 12 s

2) new battery after 15 time of 360 J discharges

From open device cover to charge 200 J done: no more than 7 s

From open device cover to charge 360 J done: no more than 14 s

From AED analysis to charge 200 J done: no more than 5 s

From AED analysis to charge 360 J done: no more than 12 s

Impedance measurement 25~300Ω

DEFIBRILLATION

ELECTRODE

Manufacture

Baisheng Medical Co., Ltd.

Model

OBS-DE/P(303A1204): Disposable defibrillation electrodes

Lifetime with sealed pouch

Up to 60 months

Total area

105±10 cm²

Maximum number of defibrillation shocks

Up to 50 shocks

BATTERY

Model

NRL01C

Battery type

LiMnO₂, 12V, 4.2Ah, non-rechargeable

Battery life in standby mode	60 months
Operating time	150 times 360 J discharge or operate 12 hours. (The equipment is powered by a new battery at 20 °C± 5 °C of ambient temperature, not performing defibrillation charges or discharges, voice volume set to low.)
Remaining charge after < Battery low > is prompted	When the remaining battery capacity is 12 %, the device will announce < Battery low >. 6 times 360 J discharge or operate 30 minutes. (The equipment is powered by a new battery at 20 °C± 5 °C of ambient temperature, not performing defibrillation charges or discharges.) If charging is no longer possible, the device automatically switches to cardiopulmonary resuscitation.

USB SPECIFICATION

USB port	1 port: USB 2.0
----------	-----------------

DATA STORAGE

ECG wave	10 hours
event	2000 events
Audio log	2 hours
self-test report	3650 reports

SAFETY

Classification	Medical product in class IIB, Device with internal power supply, Defibrillation-proof type BF
----------------	---

Identification



The product bears CE mark indicating its conformity with the provisions of the Council Directive 93/42/EEC concerning medical devices and fulfil the essential requirements of Annex I of this directive.

Classification	IP55
----------------	------

Environment specification

Operating conditions	-5°C to 55 °C,
<i>Recommended condition to save lifetime of the battery.</i>	5 to 95 % rel. humidity, but without condensation 570 hPa to 1062 hPa

Transportation and storage conditions

<i>Recommended condition to save lifetime of the battery.</i>	Short term: -30 °C~+70 °C, 5 to 95 % rel. humidity, but without condensation 570 hPa to 1062 hPa
	Long term: +15 °C~+35 °C, 5 to 95 % rel. humidity, but without condensation 570 hPa to 1062 hPa

Dimensions (L x W x H)	29.6 cm x22.0 cm x9.7 cm (±0.1 cm)
------------------------	------------------------------------

Weight	approx. 2.5 kg (with energy module, battery and pads) (±0.3 kg)
--------	---



Shock test Complies with requirements of 10.1.3a), IEC 60601-1-12:2014
Vibration test Complies with requirements of 10.1.3b) IEC 60601-1-12:2014

Other

Standards applied Standards (for licensing in the EU, the corresponding harmonised European standards EN were used instead of the IEC standards):

IEC 60601-1:2005+AMD1:2012+AMD2:2020
IEC 60601-1-2:2014+AMD1:2020
IEC 60601-2-4:2010+AMD1:2018
IEC 60601-1-6:2010+AMD1:2013+AMD2:2020
IEC 62366-1:2015+A1:2020
IEC 62304: 2006+AMD1:2015
IEC 60601-1-12:2014+A1:2020

Subject to change without notice

Appendix B: Warranty

Within 8-year warranty period, the manufacturer will remedy any defects in the device free of charge if they are based on material or manufacturing errors. The device can be reinstated to its original condition as selected by the manufacturer either by repair or replacement.

A claim under warranty does not extend the original warranty period.

Warranty and also legally entitled warranty claims are not applicable if the usefulness of the device is only negligibly affected, or in the case of normal wear and tear or damage caused after transfer of risk as a result of incorrect or negligent handling, excessive wear or are caused by special external influences which are not provided for according to the contract. The same applies if inappropriate changes or incorrect repair work is carried out by the buyer or by a third party.

All other claims against the manufacturer are excluded out unless such claims are based on intent or gross negligence or compulsory legal liability standards.

In the case of a warranty claim, please return the device with proof of purchase (e.g. invoice) stating your name and address to your dealer or to the manufacturer.

Metrax GmbH After-Sales Service is glad to be at your disposal, even after the warranty period has expired.

Appendix C: Rhythm detection system

The rhythm detection system on the HeartSave Y|YA analyses the patient's ECG and detects a shockable or non-shockable rhythm.

The algorithm

- Filters interference and measures artefacts
- Calculates several ECG signal parameters including frequency and morphological parameters - rejects implantable pacemaker artefacts
- Measures the QRS rate

Rhythm Categories

■ Shockable rhythms:

Ventricular fibrillation (VF): amplitude $\geq 0.2\text{mV}$

Pulseless Ventricular tachycardia (pVT)

■ Unshockable rhythms: normal sinus rhythm, supraventricular tachycardias, atrial fibrillation/flutter, sinus bradycardia, idioventricular rhythms, PVC (extra ventricular contraction) characteristic sinus rhythm, asystole.

Rhythm Database Source:

The ECG evaluation data in the algorithm evaluation database comes from the international standard database. The ECG data of each database can be downloaded at <https://www.physionet.org>. To collect ECG data for various rhythms, the following 8 databases were selected, which are described below:

- VFDB: MIT-BIH Malignant Ventricular Ectopy Database
- CUDB: CU Ventricular Tachyarrhythmia Database
- MITDB: MIT-BIH Arrhythmia Database
- EDB: European ST-T Database
- SVDB: MIT-BIH Supraventricular Arrhythmia Database
- AFDB: MIT-BIH Atrial Fibrillation Database
- LTAFFDB: Long Time AF Database
- SDDDB: Sudden Cardiac Death Holter Database

Test results on the performance of the equipment configured with HeartSave Y|YA shockable rhythm analysis algorithm. Meet IEC 60601-2-4 requirements.

Test results on IEC 60601-2-4 requirements are shown below.

Rhythm category	Requirement	Test result
Shockable (sensitivity):		met
VF	$\geq 90\%$	
VT, pulseless	$\geq 75\%$	
Nonshockable (specificity)	$\geq 95\%$	met
Positive predictive value	Report only	$>97\%$
False positive rate	Report only	$<2\%$

Appendix D: EMC

The equipment meets the requirements of IEC 60601-1-2: 2014.



DANGER

- Use of accessories, transducers and cables other than those specified or provided by the manufacturer of this device could result in increased electromagnetic emissions or decreased electromagnetic immunity of this device and result in improper operation.
- Avoid using this device adjacent to or stacked with other devices, as this could result in improper operation. If such use is necessary, this device and the other device should be observed to verify that they are operating normally.
- Portable RF communications equipment (including peripherals such as antenna cables and external antennas) should be used no closer than 30 cm (12 inches) to any part of this device, including cables specified by the manufacturer. Otherwise, degradation of the performance of this device could result.
- Other devices may affect this equipment even though they meet the requirements of CISPR.
- When the inputted signal is below the minimum amplitude provided in technical specifications, erroneous measurements could result.

NOTE

- ▶ The equipment needs special precautions regarding EMC and needs to be installed and put into service according to the EMC information provided below.
 - ▶ Portable and mobile RF communications equipment may affect this equipment.
 - ▶ This equipment is intended for use in professional healthcare facility environment, or in home healthcare environment such as restaurants, cafes, shops, stores, markets, schools, churches, libraries, outdoors (streets, sidewalks, parks), domiciles (residences, homes, nursing homes), train stations, bus stations, airports, hotels, hostels, pensions, museums, theaters. If it is used in special environment, such as magnetic resonance imaging environment, the equipment may be disrupted by the operation of nearby equipment.
-



The equipment is suitable for use in the electromagnetic environment specified below. The customer or the user of the equipment should assure that it is used in such an environment.

Emitted interference measurements	Conformance	Electromagnetic environment - code of practice
RF emissions according to CISPR 11	Group 1	The equipment uses RF energy only for its internal function. Therefore, its RF emissions are very low and are not likely to cause any interference in nearby electronic equipment.
RF emissions according to CISPR 11	Class B	The equipment uses RF energy only for its internal function. Therefore, its RF emissions are very low and are not likely to cause any interference in nearby electronic equipment.

The equipment is suitable for use in the electromagnetic environment specified below. The customer or the user of the equipment should assure that it is used in such an environment.

Interference immunity test	IEC 60601 test level	Level of conformance
Discharge of static electricity (ESD) according to IEC 61000-4-2	± 8 kV contact discharge ± 15 kV air discharge	± 8 kV ± 15 kV air
Magnetic field at the supply frequency (50/60 Hz) according to IEC 61000-4-8	30A/m	30A/m

NOTE	<p>UT is the mains AC before applying the impulse test level.</p> <p>If the device is operated within the electromagnetic environment listed in Table Guidance and Declaration - Electromagnetic Immunity, the equipment will remain safe and provide the following essential performance: energy accuracy, CPR function, data stored.</p>
-------------	--

The equipment is suitable for use in the electromagnetic environment specified below. The customer or the user of the equipment should assure that it is used in such an environment.

Immunity to interference testing	IEC 60601 test level	Level of conformance	Compliance level
Conducted RF interference according to IEC 61000-4-6	3 V _{rms} 150 kHz to 80 MHz	3 V _{rms}	3V _{rms} 0.15MHz~80MHz,80% AM at 1kHz (IEC 61000-4-6) 0.15MHz~80MHz,80% AM at 5Hz (IEC 60601-2-4)
	6 V _{rms} in ISM bands and amateur radio bands between 0.15 MHz and 80MHz	6 V _{rms}	6V _{rms} in ISM and amateur radio bands between 0.15MHz~80MHz,80% AM at 1kHz
Radiated RF disturbances according to IEC 61000-4-3	For EM fields: 3V/m 80MHz~2.7GHz (IEC 61000-4-3) , 1KHz,80%, AM 10V/m,20V/m, 80MHz~2.5GHz (IEC 60601-2-4) 5Hz,80%, AM		
Proximity fields from RF wireless communication s equipment IEC61000-4-3	Freq MHz	Test Level P: max power, d: distance, E: Immunity Level	Compliance level
	385MHz	P=1.8W d=0.3m E=27V/m for TETRA400	P=1.8Wd=0.3m E=27V/m for TETRA400
	450MHz	P=2W d=0.3m E=28V/m for GMRS460; FRS460	P=2W d=0.3m E=28V/m for GMRS460; FRS460
	710MHz	P=0.2W d=0.3m E=9V/m for LTE Band 13, 17	P=0.2W d=0.3m E=9V/m for LTE Band 13, 17
	745MHz		
	780MHz		
	810MHz	P=2W d=0.3m E=28V/m for GSM800/900; TETRA800; iDEN820; CDMA850; LTE-Band 5	P=2W d=0.3m E=28V/m for GSM800/900; TETRA800; iDEN820; CDMA850; LTE-Band 5
	870MHz		
	930MHz		
	1720MHz	P=2W d=0.3m E=28V/m for GSM1800, CDMA1900; GSM1900; DECT; LTE-Band 1,3,4,35; UMTS	P=2W d=0.3m E=28V/m for GSM1800, CDMA1900; GSM1900; DECT; LTE-Band 1,3,4,35; UMTS
	1845MHz		
1970MHz			

	2450MHz	P=2W d=0.3m E=28V/m for Bluetooth, WLAN 802.11 b/g/n, RFID 2450, LTE Band 7	P=2W d=0.3m E=28V/m for Bluetooth, WLAN 802.11 b/g/n, RFID 2450, LTE Band 7
	5240MHz	P=0.2W d=0.3m E=9V/m for WLAN 802.11 a/n	P=0.2W d=0.3m E=9V/m for WLAN 802.11 a/n
	5500MHz		
	5785MHz		

- NOTE**
- ▶ The equipment is intended for use in an electromagnetic environment in which radiated RF disturbance are controlled. The customer or user of the equipment can help prevent electromagnetic interference by maintaining a minimum distance between portable and mobile RF communications equipment (transmitters) and the equipment, as recommended below, according to the maximum output power of the communication equipment.
 - ▶ If the device is operated within the electromagnetic environment listed in Table **Guidance and Declaration - Electromagnetic Immunity**, the equipment will remain safe and provide the following essential performance: energy accuracy, CPR function, data stored.
 - ▶ These guidelines may not be applicable in all cases. The spread of electromagnetic factors is affected by absorption and reflection from buildings, objects and people.

Appendix E: Index Diagram

Fig. 1 Front view with lid	14
Fig. 2 Back View	14
Fig. 3 Bottom View	15
Fig. 4 HeartSave Y YA series front view	15
Fig. 5 Accessory kit of the HeartSave Y YA	16
Fig. 6 Inserting defibrillation electrode	17
Fig. 7 Insert the battery	18
Fig. 8 Removing the battery	19
Fig. 9 Plug in defibrillation electrode cable	22
Fig. 10 Removing the foil from defibrillation electrode	23
Fig. 11 Position of defibrillation electrode on adults	24
Fig. 12 Position of defibrillation electrode on children	24
Fig. 13 Disposal	31

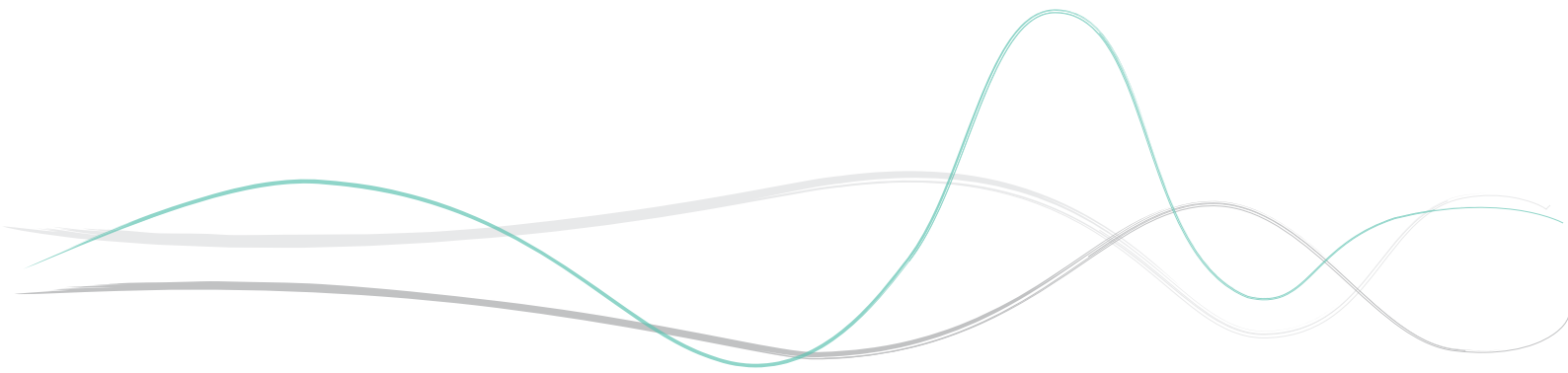

Jiangsu Yuyue Medical Equipment & Supply Co., Ltd

No.1 Baisheng Road Development Zone, Danyang, Jiangsu
Postal Code: 212300
Peoples Republic of China
Phone: +86 511 86900833
Fax: +86 511 86900851
www.yuyue.com/en

Metrax GmbH

Rheinwaldstraße 22
78628 Rottweil
Germany
Phone: +49 741 257 0
E-Mail: info@primedic.com
www.primedic.com

WEEE-Reg.-No.: 73450404

